

4G Sensor Antenna

FEATURES & BENEFITS

- Lightweight, low profile and rugged design
- Easy installation with built-in bolt interface, can be directly screwed onto devices without additional screws.
- UV-resistant, Impact-resistant, dustproof and waterproof
- RF cables and connectors customization supported

APPLICATIONS

Various IoT applications, including,

- Smart valves
- Pressure/Level/Flow transmitters
- Temperature transmitters
- Water meters ect.



ORDER INFORMATION

Product Name	4G Sensor Antenna
Part Number	M02-0501100R0A
Dimensions	Ø32 x 68 mm
Weight	30 g
Color	Black
Mounting	Screw mount
4G Antenna Cable	Default IPEX 1 RF 1.13 black coaxial cable (Ø 1.13 x 172 mm) , customizable.

REFERENCE GUIDE

Technical Features (MHz)	824-960	1710-2690
Max VSWR	2.0:1	2.5:1
Max Efficiency	90.61%	
Peak Gain	2.62dBi	
Radiation Pattern	Directional	
Polarization	Linear	
Input Impedance	50 Ω	
Operating Temperature	-40°C to +85°C	
Storage Temperature	-40°C to +85°C	
Relative Humidity	10 to 70%	
Material Substance Compliance	RoHS Compliant	
Dimensions (L x W x H)	Ø32 x 68 mm	
All data were measured on a water meter as shown on cover with an 172-mm-long RF 1.13 cable.		

Application data might vary.

ELECTRICAL PERFORMANCE

- Note

All data displayed in "ELECTRICAL PERFORMANCE" were measured on the water meter as shown below with an 85-mm-long RF 1.13 cable.



A sample of use cases: Antenna mounted on a water meter

ELECTRICAL DATA (Data tested on a water meter with 172 mm of RF 1.13 cable)

Return Loss

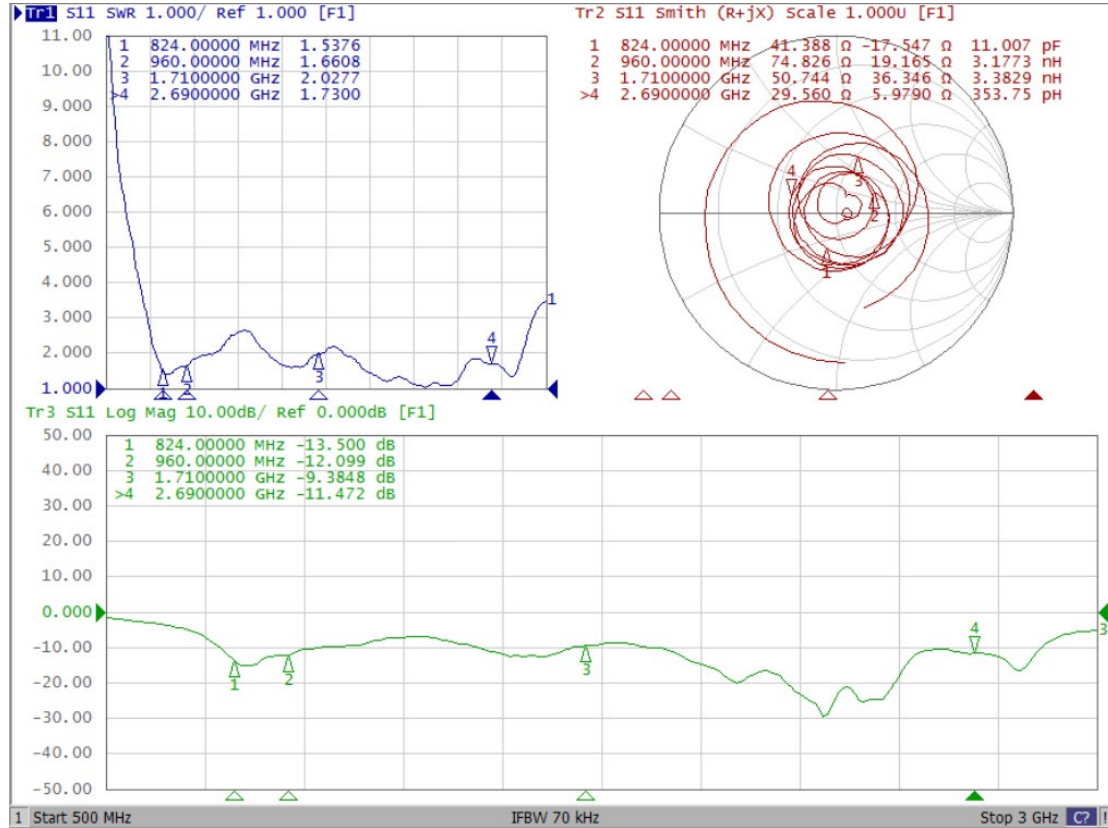

Efficiency (%)

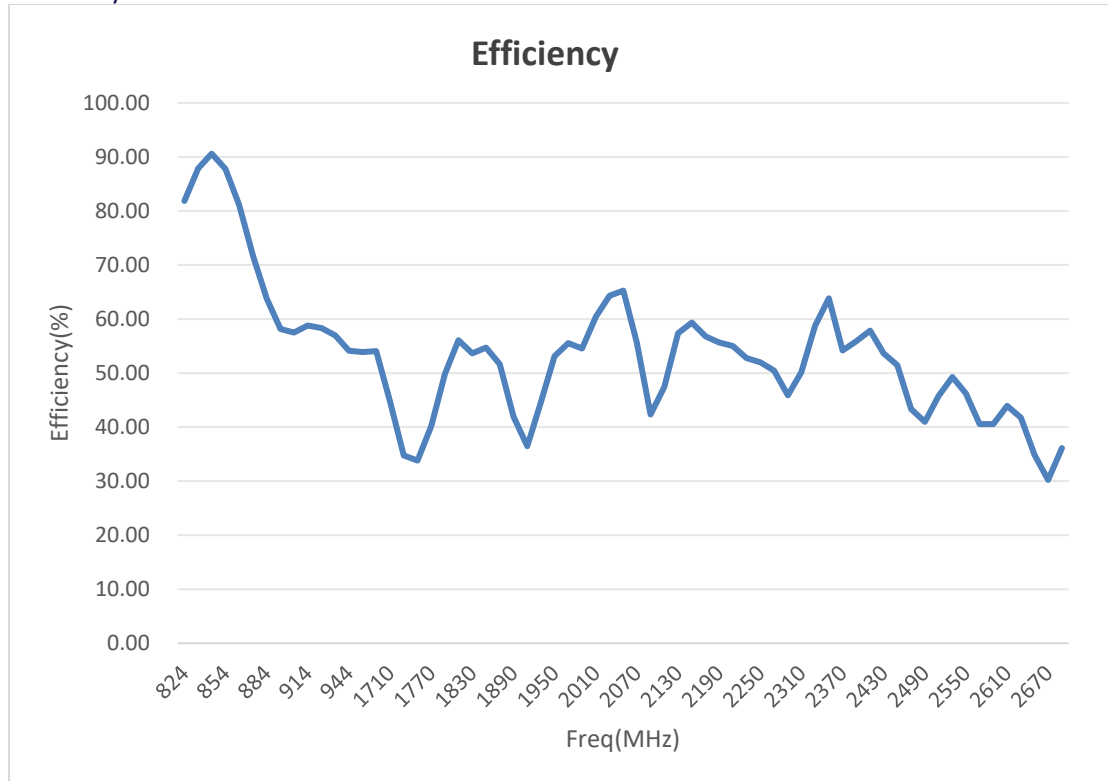

Peak Gain (dBi)

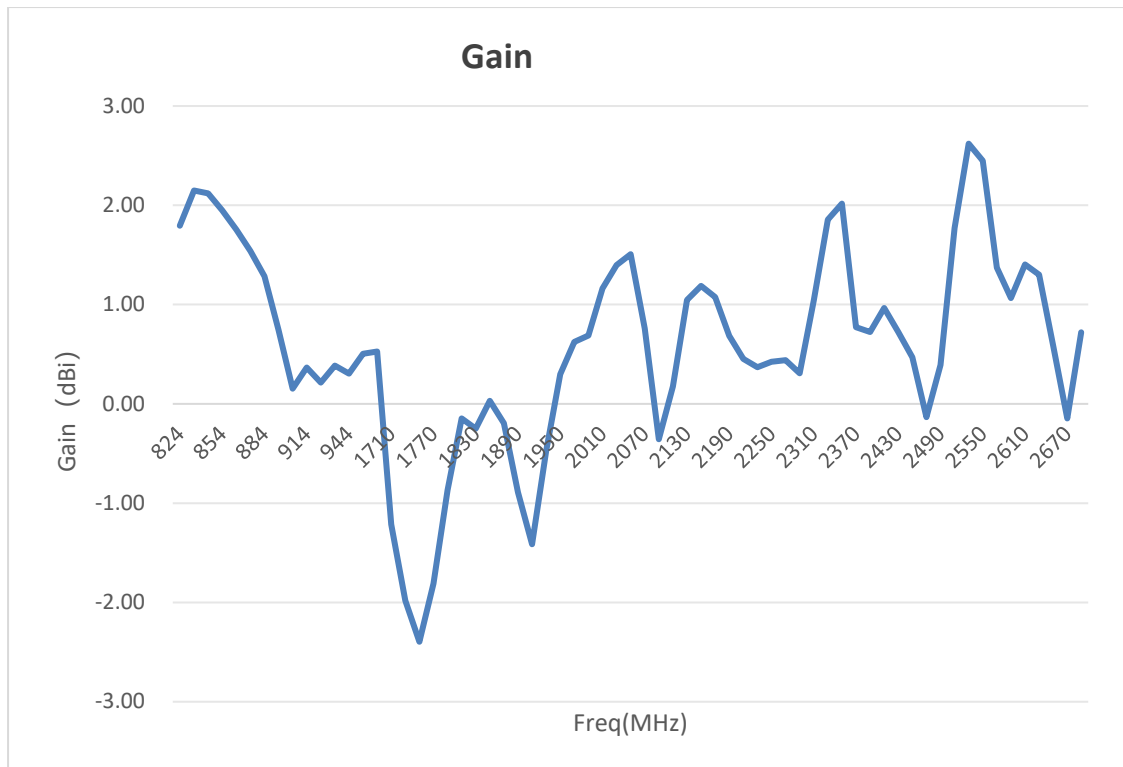

Freq(MHz)	Gain (dBi)	Efficiency(%)	Freq(MHz)	Gain (dBi)	Efficiency(%)	Freq(MHz)	Gain (dBi)	Efficiency(%)
824	1.80	81.84	1850	0.03	54.73	2290	0.31	45.90
834	2.15	87.91	1870	-0.19	51.61	2310	1.04	50.18
844	2.12	90.61	1890	-0.89	41.91	2330	1.86	58.77
854	1.95	87.78	1910	-1.42	36.44	2350	2.02	63.84
864	1.76	81.11	1930	-0.48	44.54	2370	0.77	54.16
874	1.54	71.70	1950	0.30	53.10	2390	0.72	55.87
884	1.29	63.79	1970	0.62	55.57	2410	0.97	57.83
894	0.74	58.13	1990	0.69	54.56	2430	0.72	53.64
904	0.15	57.48	2010	1.16	60.38	2450	0.47	51.47
914	0.37	58.81	2030	1.40	64.31	2470	-0.13	43.35
924	0.21	58.31	2050	1.51	65.29	2490	0.39	40.97
934	0.38	56.94	2070	0.76	55.67	2510	1.77	45.76
944	0.30	54.11	2090	-0.35	42.33	2530	2.62	49.27
954	0.50	53.88	2110	0.18	47.41	2550	2.45	46.22
960	0.53	54.09	2130	1.05	57.37	2570	1.37	40.57
1710	-1.21	44.76	2150	1.19	59.36	2590	1.07	40.56
1730	-1.98	34.74	2170	1.07	56.81	2610	1.41	43.92
1750	-2.40	33.79	2190	0.68	55.66	2630	1.30	41.72
1770	-1.81	40.23	2210	0.45	55.01	2650	0.58	34.82
1790	-0.87	49.91	2230	0.37	52.75	2670	-0.15	30.23
1810	-0.15	56.09	2250	0.42	51.97	2690	0.72	36.13
1830	-0.25	53.67	2270	0.44	50.47			

RADIATION PATTERNS(Data tested on a water meter with 172 mm of RF 1.13 cable)

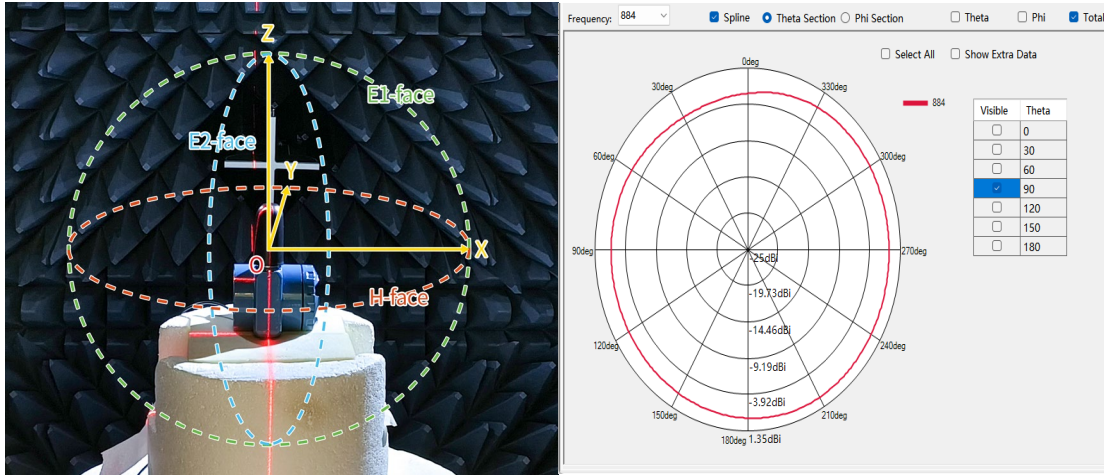

The Antenna in MyAntenna's Anechoic Chamber

$\theta = 90^\circ$ Plane XY at 884MHz

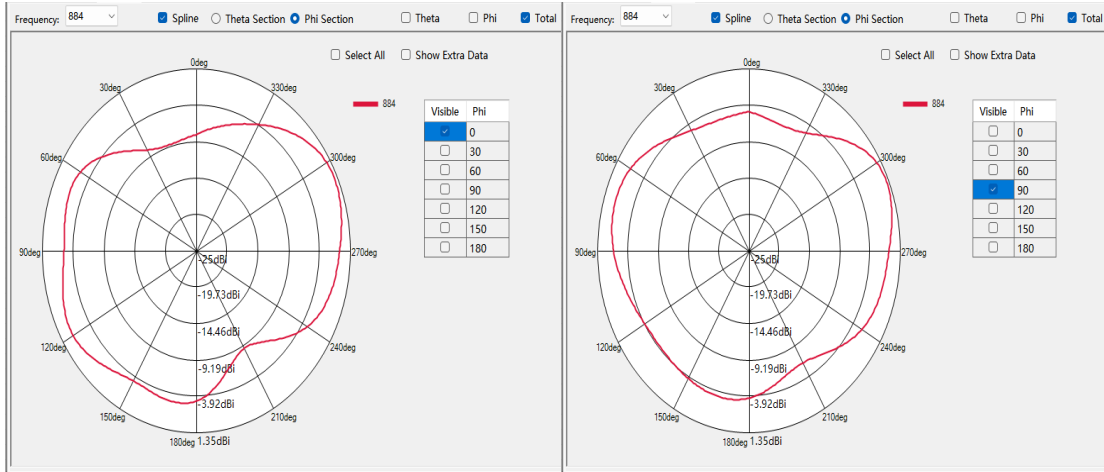

$\Phi = 0^\circ$ Plane XZ at 884MHz

$\Phi = 90^\circ$ Plane YZ at 884MHz

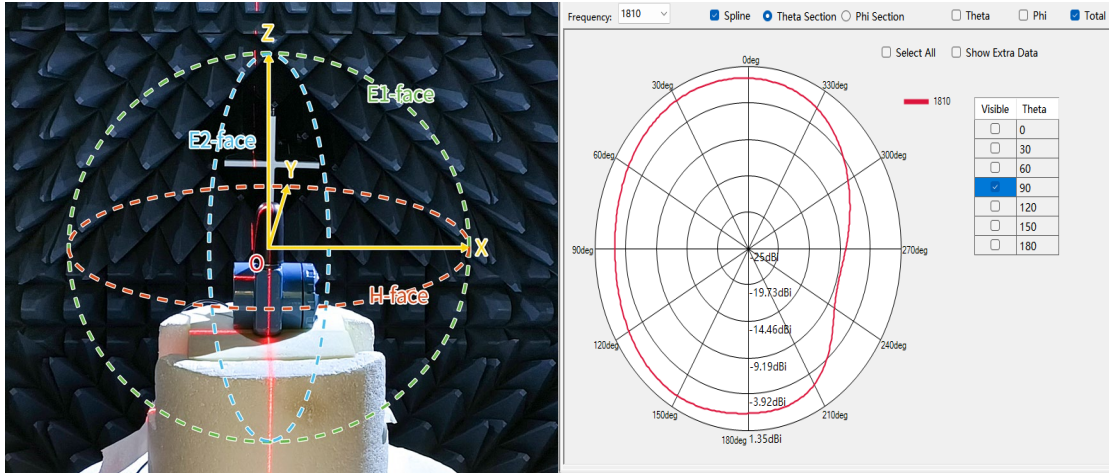

The Antenna in MyAntenna's Anechoic Chamber

$\theta = 90^\circ$ Plane XY at 1810MHz

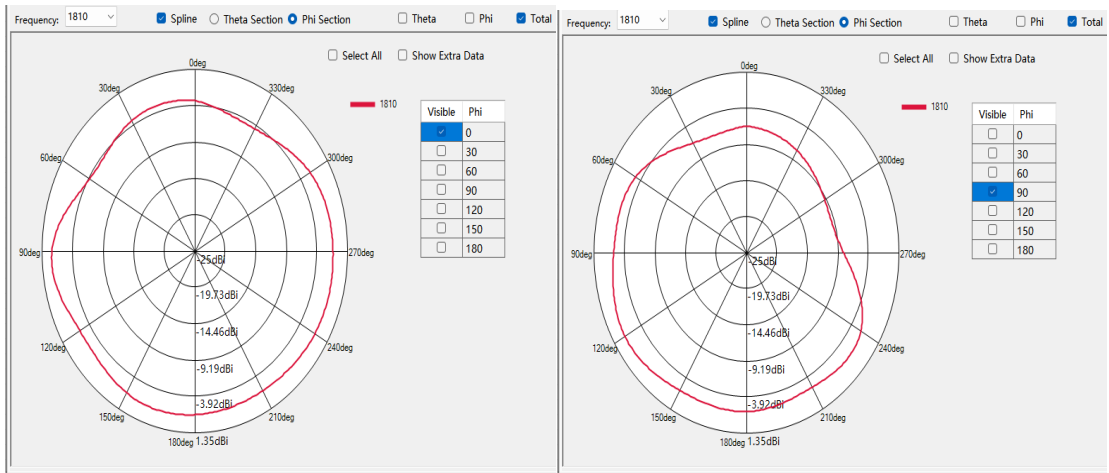

$\Phi = 0^\circ$ Plane XZ at 1810MHz

$\Phi = 90^\circ$ Plane YZ at 1810MHz

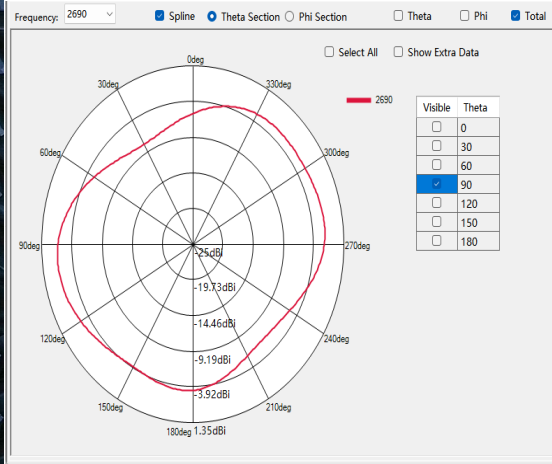
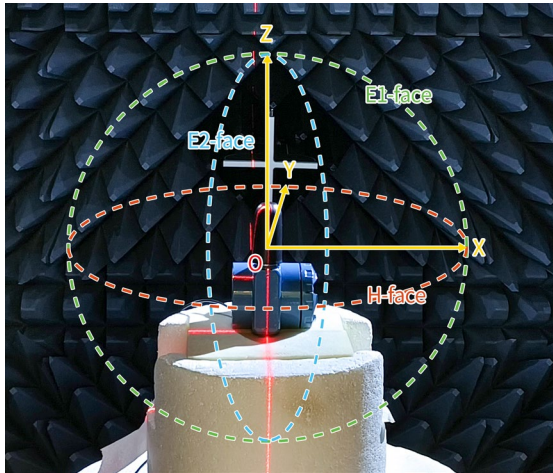

The Antenna in MyAntenna's Anechoic Chamber

$\theta = 90^\circ$ Plane XY at 2690MHz

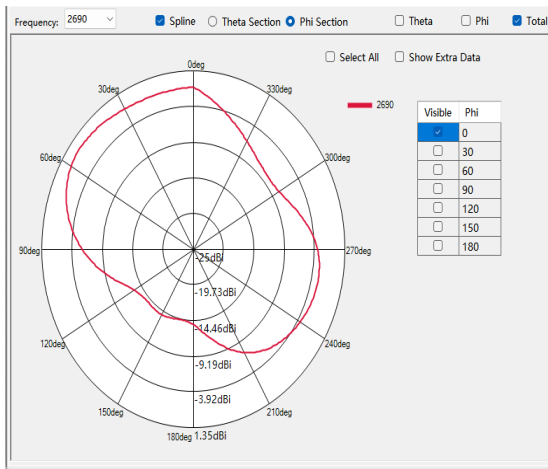

$\phi = 0^\circ$ Plane XZ at 2690MHz

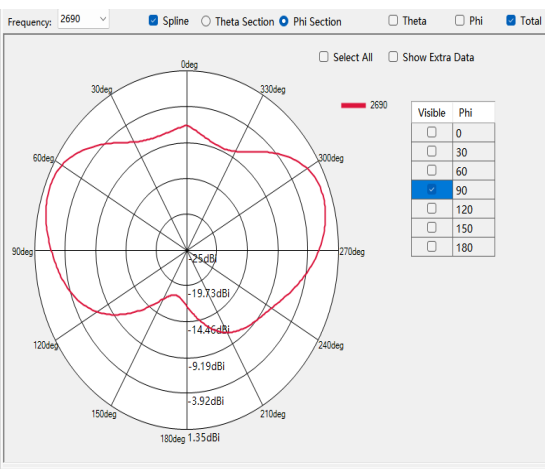

$\phi = 90^\circ$ Plane YZ at 2690MHz

3D Radiation Pattern at 884MHz

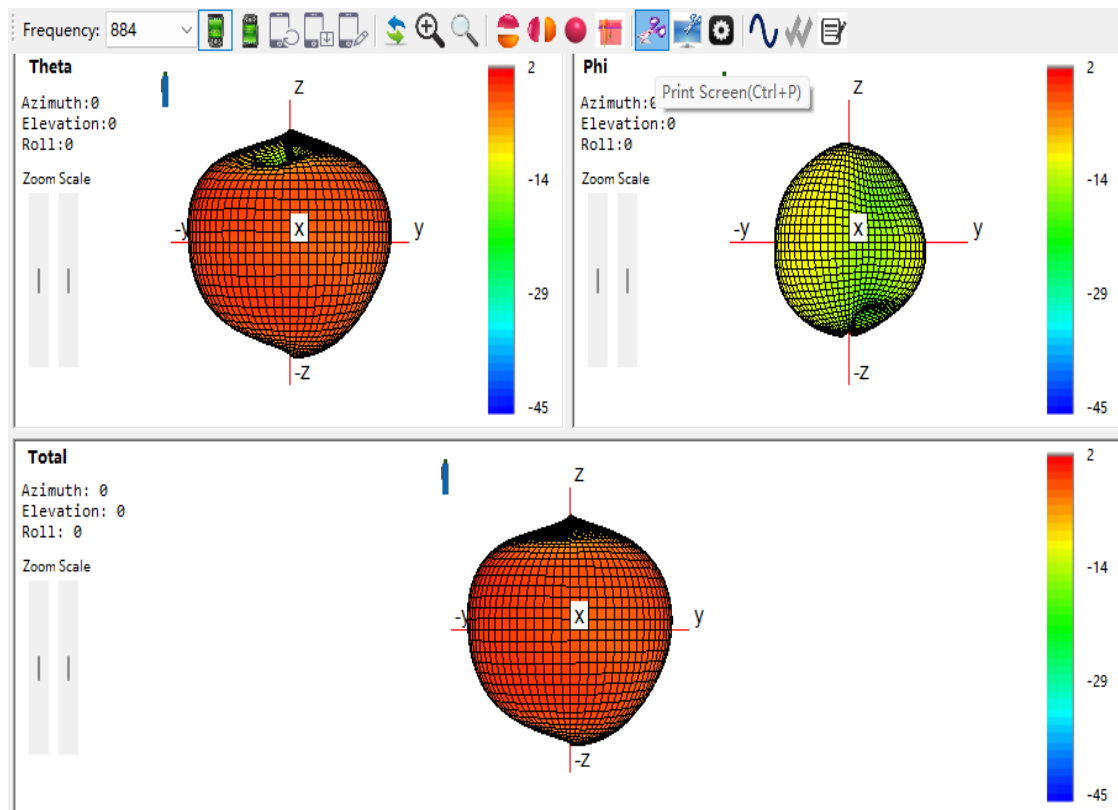

3D Radiation Pattern at 1810MHz

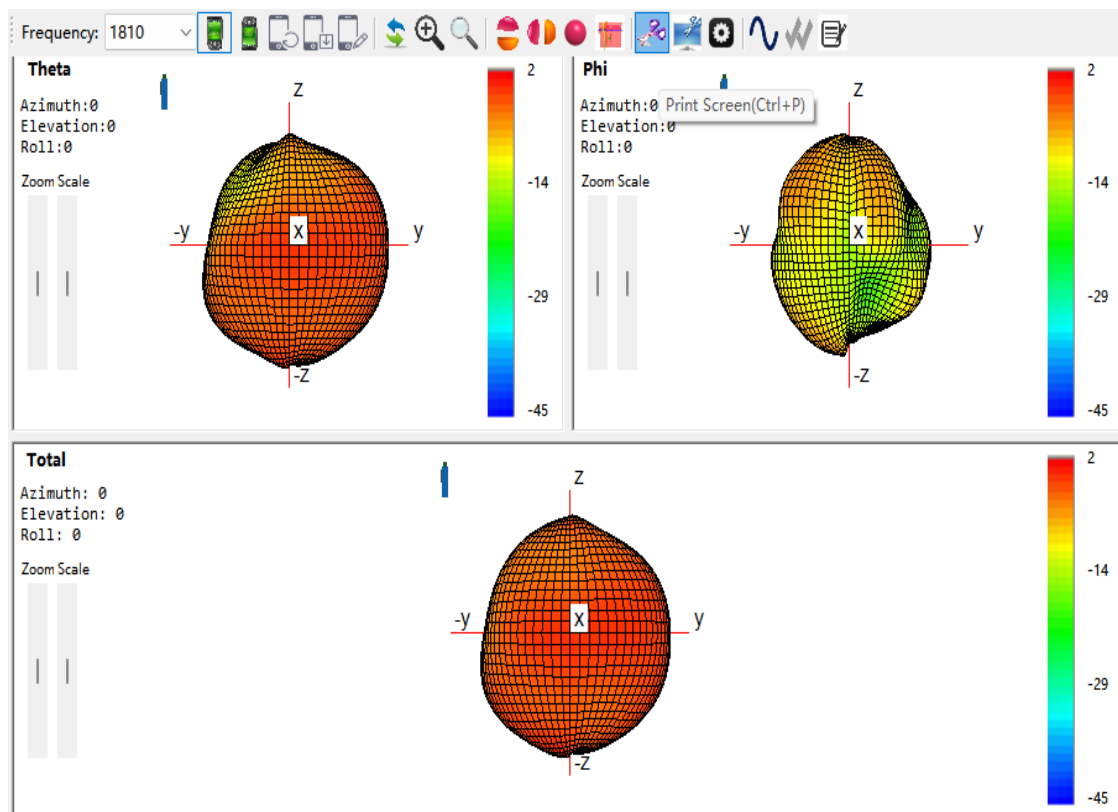

3D Radiation Pattern at 2690MHz

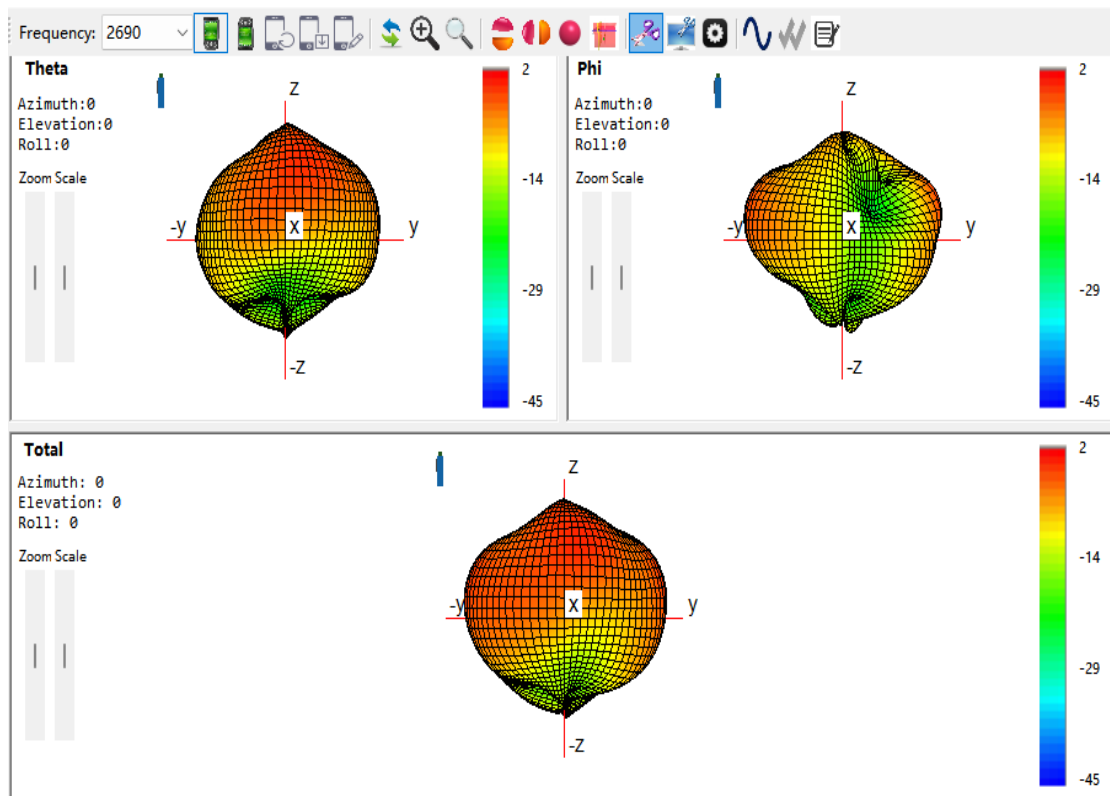

HOUSING CONFIGURATIONS

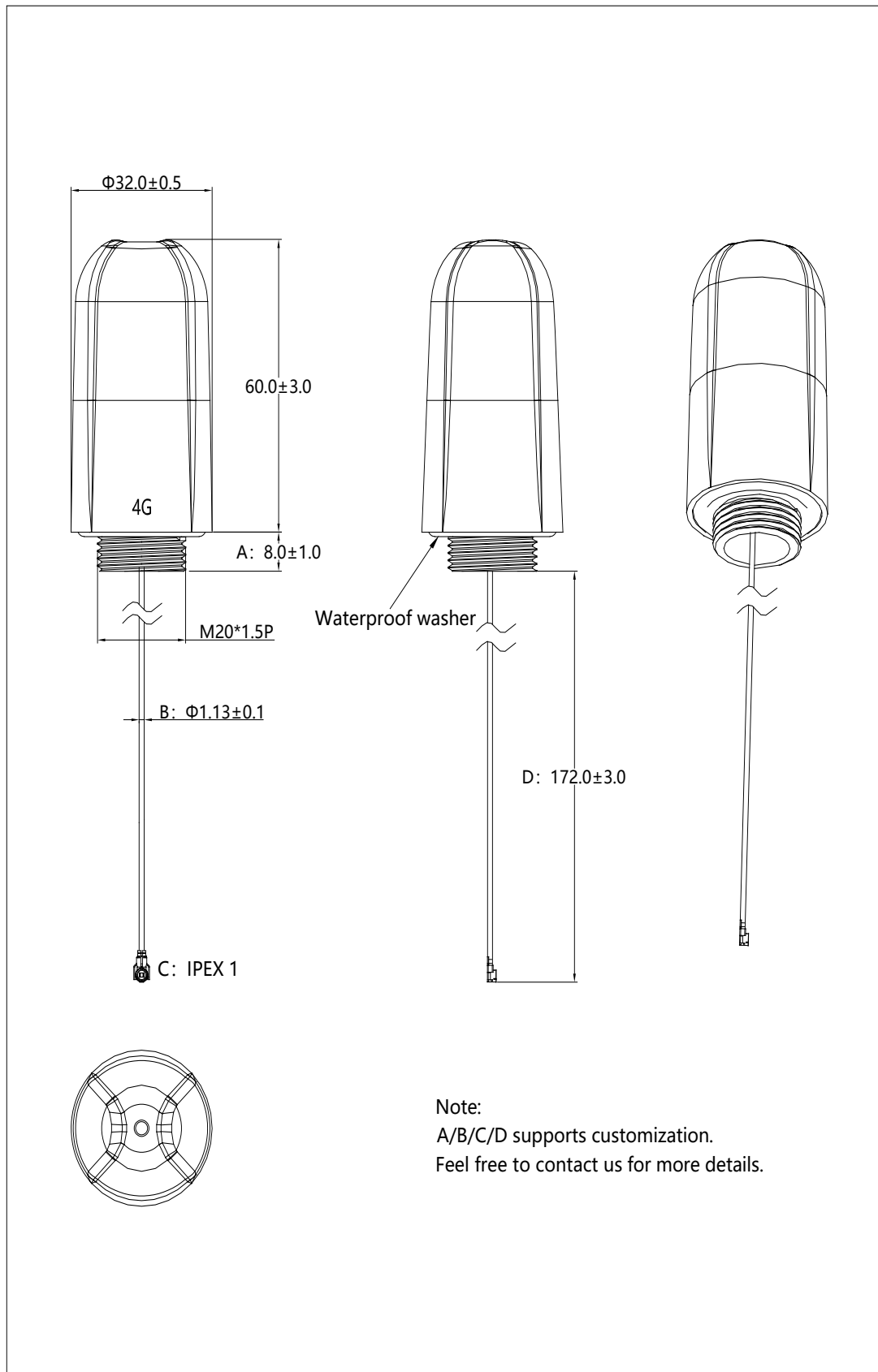



Aboosty™ is owned by Shenzhen MyAntenna RF Technology Co., Ltd. (often abbreviated as MyAntenna).