

4G/3G/2G

CAT1 LORA COMBINATION SMD ANTENNA



698-960 MHz | 1710-2690 MHz

Dimensions: 49.6 x 8.0 x 3.2 mm

Clearance Area: 50 x 12 mm



PN: M01-0500720R0A





Table of Contents

1 FEATURES & BENEFITS	1
2 APPLICATIONS.....	1
3 ORDER INFORMATION.....	1
4 REFERENCE GUIDE	2
5 EVALUATION BOARD	2
6 MATCHING NETWORK.....	3
7 RECOMMENDED FOOTPRINT AND LAYOUT	3
8 ELECTRICAL PERFORMANCE	5
8.1 VSWR and Total Efficiency	5
8.2 Radiation Patterns (698-960 MHz), Efficiency (%) and Gain (dBi).....	6
8.3 Radiation Patterns (1710-2690 MHz), Efficiency (%) and Gain (dBi).....	7
9 SOLDERING CONDITIONS.....	8
10 PACKAGING	8
10.1 Optimal Storage Conditions for Packaged Reels	8
10.2 Packagings and Dimensions (Unit: mm).....	9
11 ANTENNA CERTIFICATION	10
12 WELCOME ALL ANTENNA OEM/ODM PROJECTS.....	11

www.aboosty.com

The materials provided herein, which are intended for illustration purposes only, are believed to be reliable and correct. However, no responsibility is further assumed for inaccuracies or incompleteness, and all such information shall be entirely at the user's risk. All information is subject to change without prior notice.

Copyright © 2024 ShenZhen MyAntenna RF Technology Co., Ltd. All Rights Reserved.



1 FEATURES & BENEFITS

- Low Profile
- Light Weight
- Easy to Integrate
- Intended for SMD Mounting
- Reduced Cost and Time-to-Market

2 APPLICATIONS

- 3G (UMTS) and 4G (LTE) Mobile Communication Networks
- Wireless Routers and Modems
- Internet of Things (IoT) Devices, M2M
- Remote Technology / Monitoring
- Consumer Tracking
- Smart Metering

Items	Dimensions (mm)
Length	49.6±0.2
Width	8.0±0.2
Thickness	3.2±0.2

3 ORDER INFORMATION

Product Name	4G/3G/2G, Cat 1, LoRa Combination SMD Antenna
Part Number	M01-0500720R0A
Dimensions	49.6 x 8.0 x 3.2 mm
Weight	2.63 g
Mounting	SMT
Packaging	Tape & Reel
MOQ	1500 pcs/reel

4 REFERENCE GUIDE

Technical Features	698-960 MHz	1710-2690 MHz
Max VSWR	6.9:1	2.5:1
Max Efficiency	78.9%	
Max Return Loss	-2.7 dB	
Peak Gain	Up to 3.01 dBi (Typ)	
Max Input Power	2 Watts CW	
Polarization	Linear	
Input Impedance	50 Ω	
Operating Temperature	-40°C to +80°C	
Relative Humidity	10 to 70%	
Dimensions (L x W x H)	49.6 x 8.0 x 3.2 mm	
All data were measured in free space and on a reference ground plane of 150 mm length, 50 mm width, and 1.6 mm thickness. Application data might vary.		

5 EVALUATION BOARD

The evaluation board provides operation at 698-960, 1710-2690 MHz.
Evaluation Board dimension: 150 x 50 x 1.6 mm



6 MATCHING NETWORK

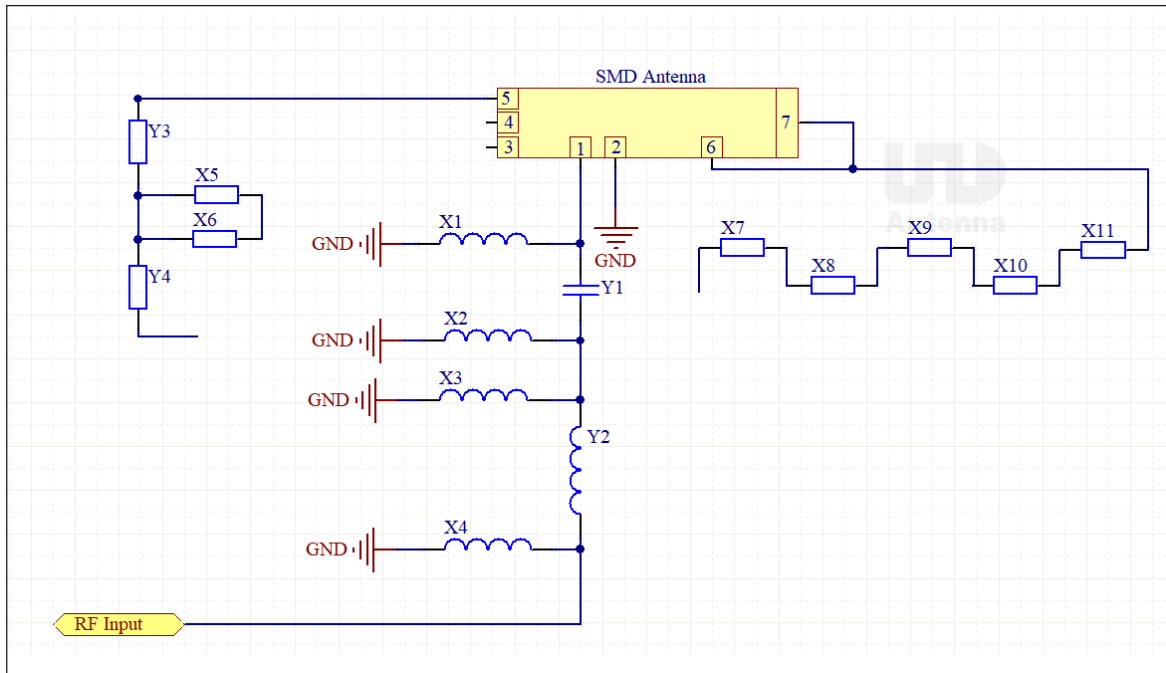

7 RECOMMENDED FOOTPRINT AND LAYOUT

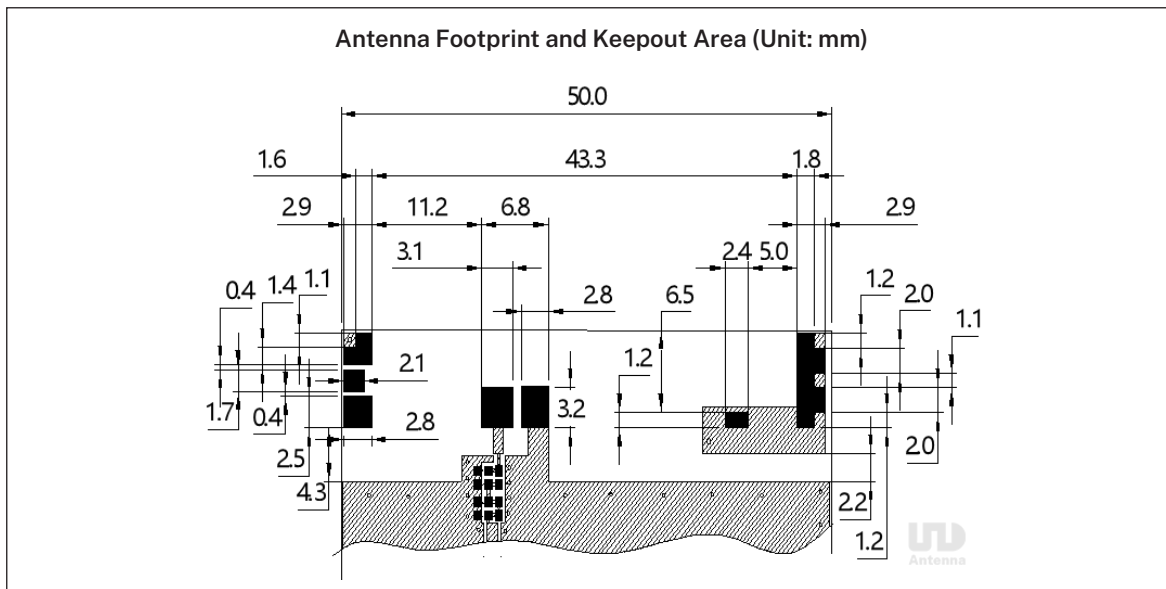

It's strongly recommended to place the antenna near the edge of the board. Maximum antenna performance is achieved by placing the antenna towards one of the corners of the PCB and with the feed point of the antenna as close to same corner of the PCB as possible.

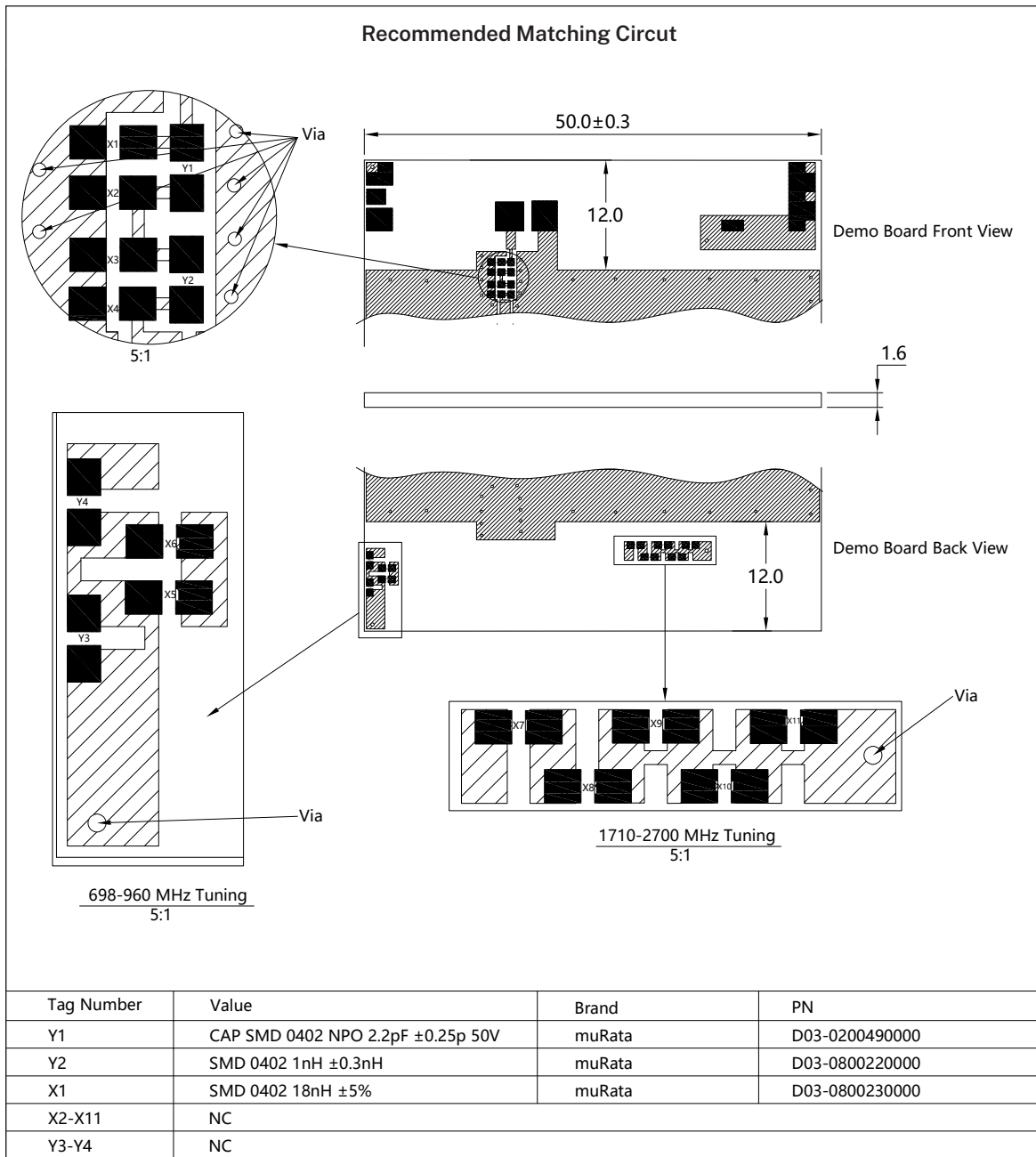

8 ELECTRICAL PERFORMANCE

© Note

All data displayed in Chapter 8 were measured in free space and on a reference ground plane of 150 mm length, 50 mm width, and 1.6 mm thickness.

8.1 VSWR and Total Efficiency

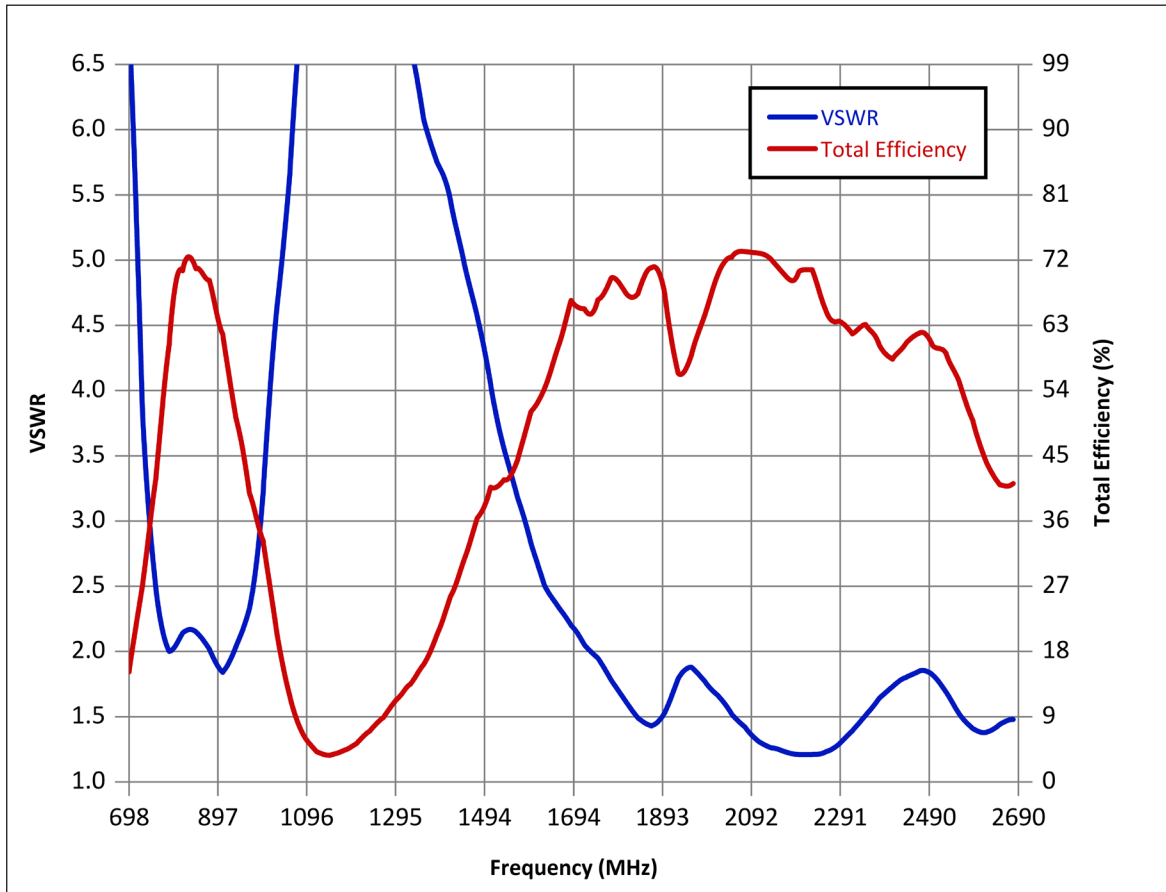

8.2 Radiation Patterns (698-960 MHz), Efficiency (%) and Gain (dBi)

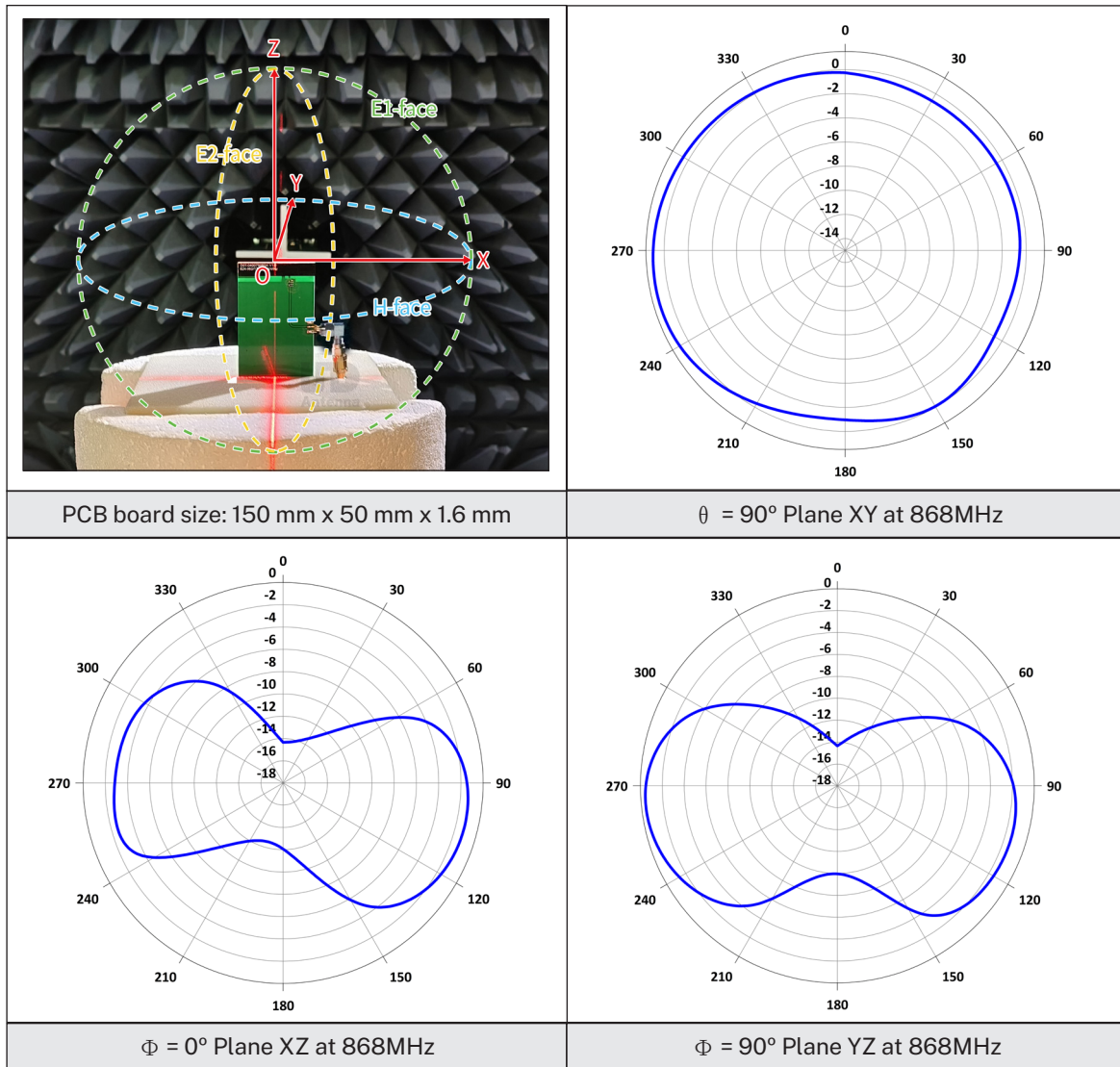

Gain	Peak Gain	1.2 dBi
	Average Gain across the band	-0.4 dBi
	Gain Range across the band (min, max)	-7.2 to 1.2 dBi
Efficiency	Peak Efficiency	73.5%
	Average Efficiency across the band	53.4%
	Efficiency Range across the band (min, max)	15.2 to 73.5%

8.3 Radiation Patterns (1710-2690 MHz), Efficiency (%) and Gain (dBi)

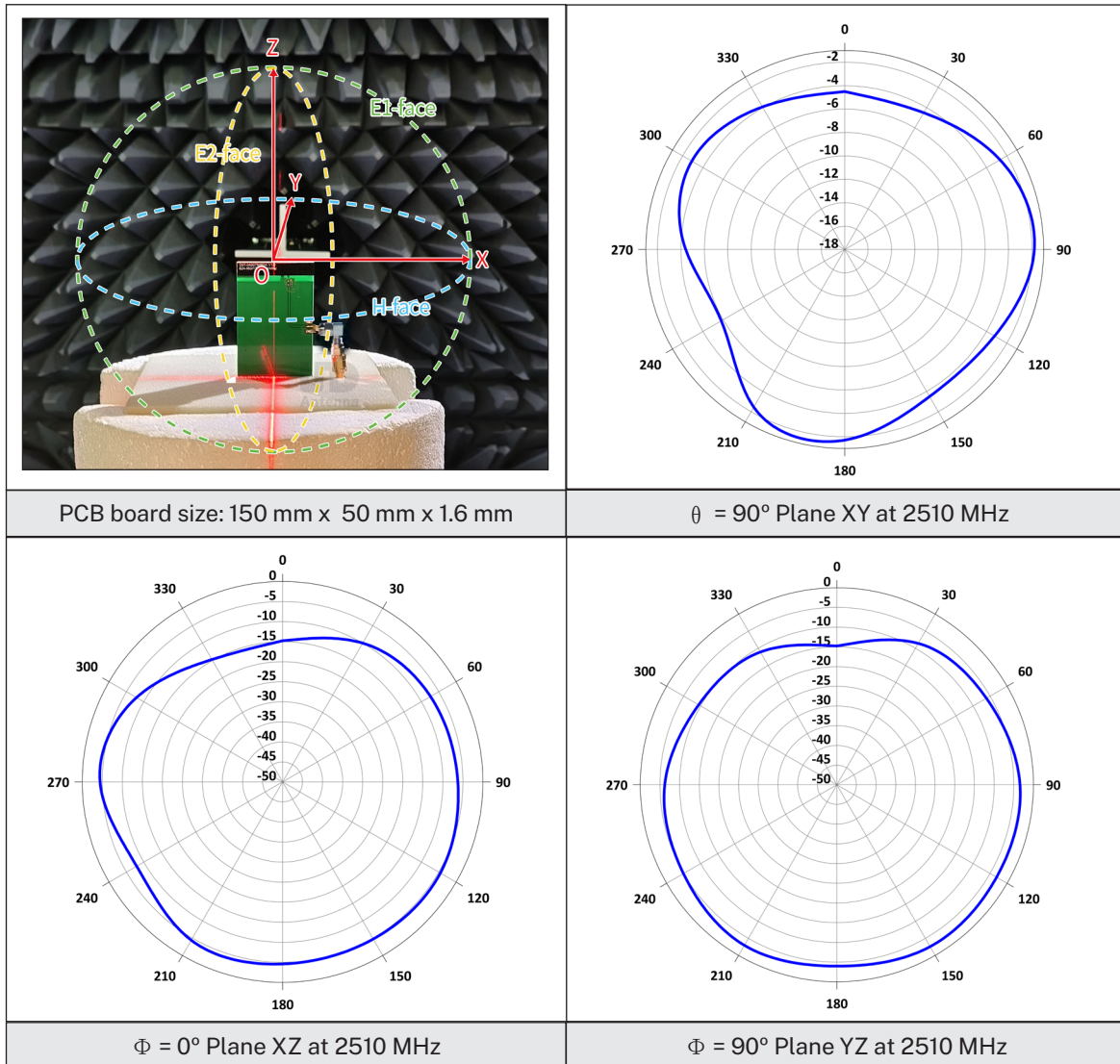

Gain	Peak Gain	3.0 dBi
	Average Gain across the band	1.5 dBi
	Gain Range across the band (min, max)	-0.01-3.0 dBi
Efficiency	Peak Efficiency	78.9%
	Average Efficiency across the band	62.6%
	Efficiency Range across the band (min, max)	35.2 to 78.9%

9 SOLDERING CONDITIONS

This antenna is suitable for lead free soldering.

The reflow duration should be adjusted to create good solder joints without raising the antenna temperature beyond the allowed maximum of 260°C.

The figure below shows the temperature profile for soldering.

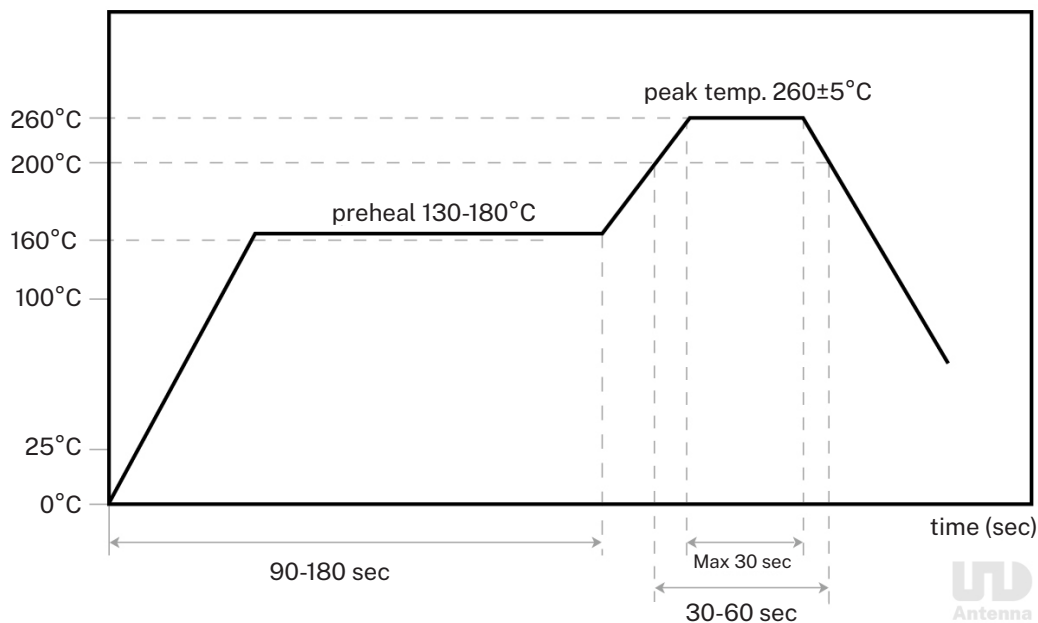

10 PACKAGING

10.1 Optimal Storage Conditions for Packaged Reels

Temperature	-5°C to 40°C
Humidity	Less than 70% RH
Shelf life	18 months
Storage place	Away from corrosive gas and direct sunlight
Packaging	Reels should be stored in unopened sealed manufacturer's plastic packaging.

© **Note**

Storage of open reels of antennas is not recommended due to possible oxidation of pads on antennas. If short-term storage is necessary, then it is highly recommended that the bag containing the antenna reel is re-sealed and stored in like storage conditions as in the above table.

10.2 Packagings and Dimensions (Unit: mm)

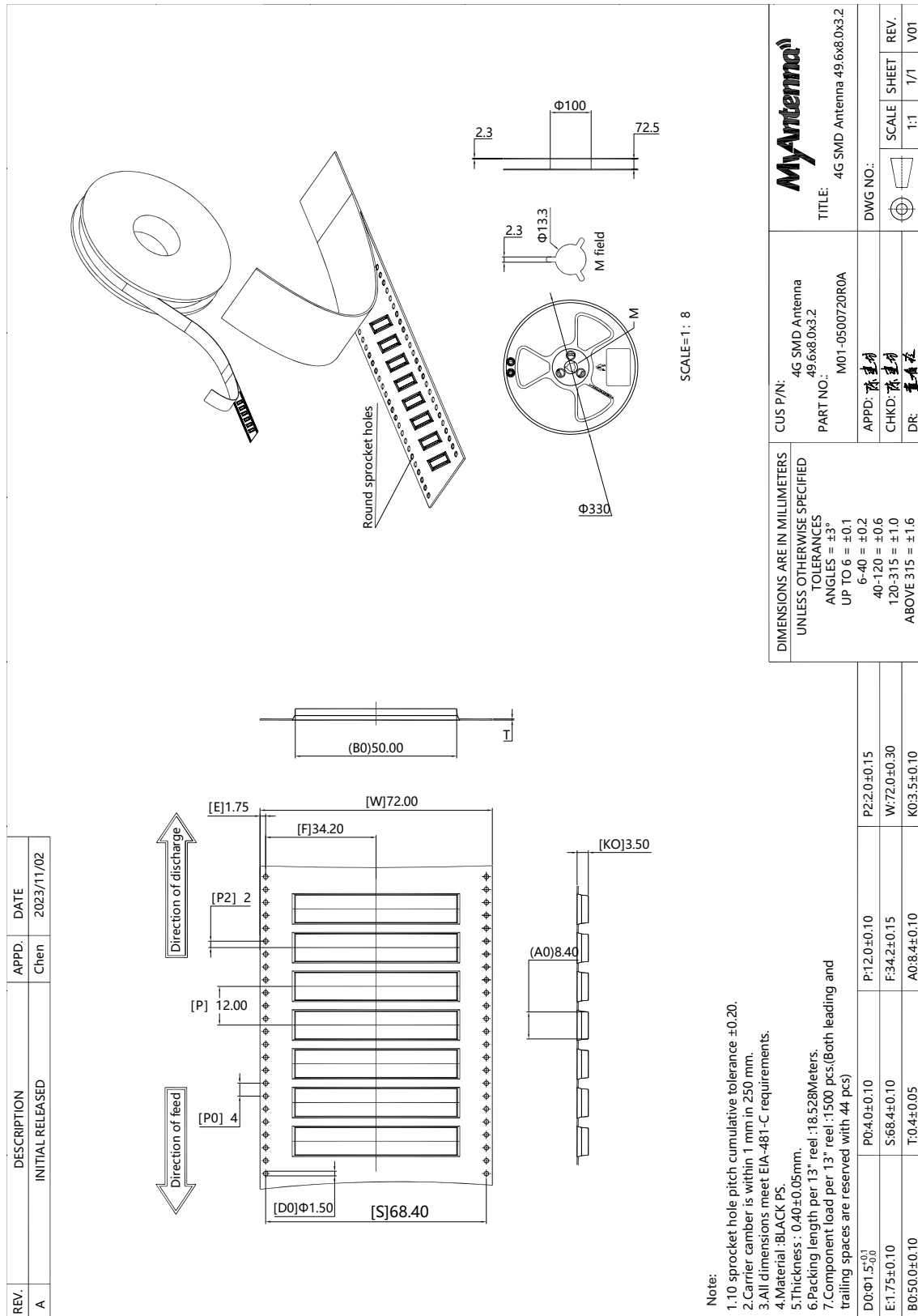



11 ANTENNA CERTIFICATION

RoHS Approval	Compliant [2011/65/EU&2015/863]
REACH Approval	Conform or declared [(EC)1907/2006]
Hazardous material regulation conformance: A certificate of conformance is available upon request. Feel free to consult us for details.	



12 WELCOME ALL ANTENNA OEM/ODM PROJECTS

About ABOOSTY



10+ years in antenna R&D, production, and OEM/ODM



House of Aboosty: 450,000 units annual output capacity



Factory directly competitive price



Industry-leading quality levels



Professional team-work & support



Quick price and lead time estimation

Why Choose ABOOSTY



Innovative and patented design solutions



Full terminal devices anechoic chamber test



Co-location with its custom



Competitive price



Strict inspection



Prompt reply within 24h

What We Provide

OEM/ODM Services	
Light Customization	Deep Customization
<ul style="list-style-type: none"> • Logo • Packaging • Cables&Connectors 	<ul style="list-style-type: none"> • In-depth tailoring for specific applications • Functional enhancements • Environmental adaptations • Vertical certifications • ...

Custom Process

Light Customization Process

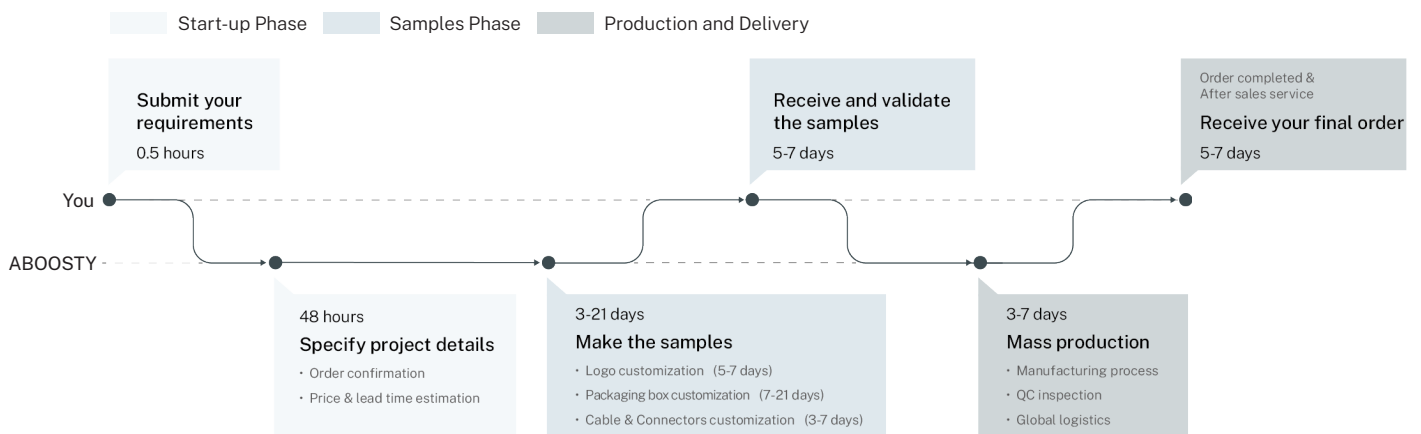



Deep Customization Process

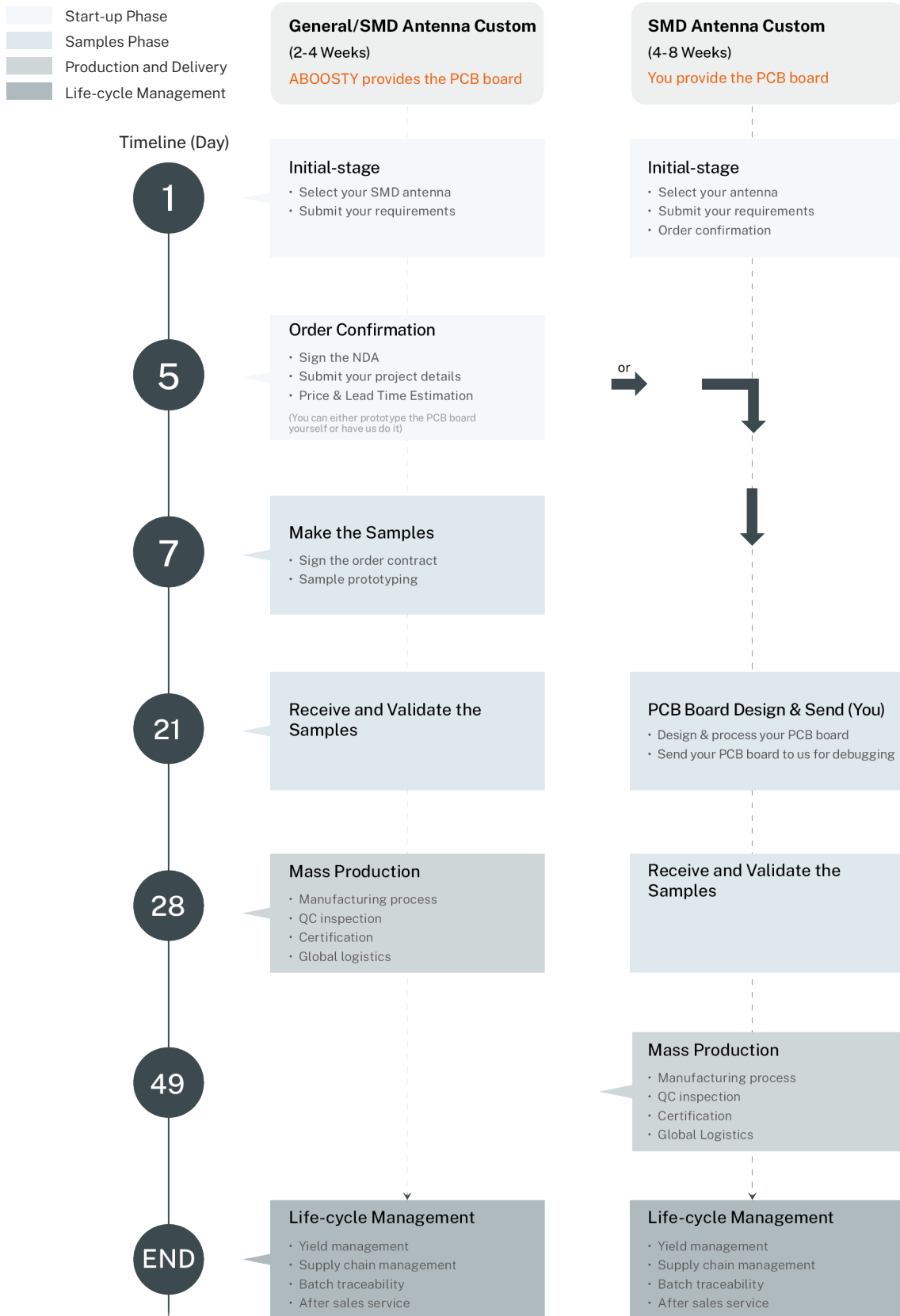

ABOOSTY

A Globally Leading Manufacturer and Supplier of
Multi-band Combination Antennas

Visit us at www.aboosty.com

✉ support@aboosty.com 📞 +86 13924678201

